



WANSEMI
万芯半导体

WP9926B

Enhancement Mode N-Channel Power MOSFET

SOP8/NMOS/20V/ ± 12 V/0.75V/6A/18m Ω

Rev0.4

20V, 18mΩ, 6A, N-Channel Enhancement Mode Power MOSFET

1.Features

- ◆ High Power and current handing capability
- ◆ Lead free product is acquired
- ◆ Surface Mount Package

V _{DS} Typ	R _{DS(on)} Typ.	I _D Max.
20V	18mΩ @ 4.5V	6A
	25mΩ @ 2.5V	

2.Applications

- ◆ Battery protection
- ◆ Load Switch
- ◆ Power management

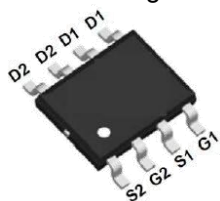

SOP8

Pin Description

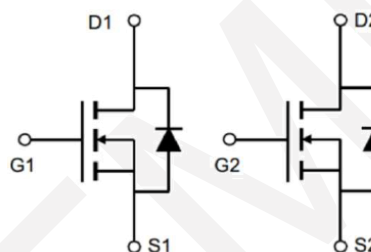

Schematic Diagram

3.Package Marking and Ordering Information

Part no.	Marking	Package	PCS/Tube	PCS/CTN.
WP9926B	9926B	SOP8	4,000	48,000

4.Absolute Max Ratings at Ta=25°C (Note1)

Parameter	Symbol	Maximum	Units
Drain to Source Voltage	V _{DSS}	20	V
Gate to Source Voltage	V _{GSS}	±12	V
Drain Current-Continuous	I _D	6	A
Drain Current (Pulse)	I _{DM}	20	A
Maximum Power Dissipation	P _D	2	W
Operating Junction and Storage Temperature Range	T _j , T _{stg}	-55 to +150	°C

Note 1: Stresses exceeding those listed in the Maximum Ratings table may damage the device. If any of these limits are exceeded, device functionality should not be assumed, damage may occur and reliability may be affected.

5.Thermal Characteristic

Parameter	Symbol	Value	Unit
Thermal Resistance, Junction to Ambient (Note 2)	R _{θJA}	56	°C/W

Note 2: When mounted on 1 inch square copper board t ≤ 10sec The value in any given application depends on the user's specific board design.

6. Electrical Characteristics at Ta=25°C (Note 3)

Parameter	Symbol	Test Conditions	Min.	Typ.	Max.	Units
Drain to Source Breakdown Voltage	$V_{(BR)DSS}$	$I_D = 250\mu A, V_{GS} = 0V$	20	-	-	V
Zero-Gate Voltage Drain Current	I_{DSS}	$V_{DS} = 20V, V_{GS} = 0V$	-	-	1	μA
Gate-Body Leakage Current	I_{GSS}	$V_{GS} = \pm 12V, V_{DS} = 0V$	-	-	± 100	nA
Gate Threshold Voltage	$V_{GS(th)}$	$V_{DS} = V_{GS}, I_{DS} = 250\mu A$	0.45	0.75	1.2	V
Drain to Source On-State Resistance	$R_{DS(on)}$	$I_D = 6A, V_{GS} = 4.5V$	-	18	24	m Ω
		$I_D = 5A, V_{GS} = 2.5V$	-	25	33	m Ω
Diode Forward Voltage	V_{SD}	$I_S = 1.7A, V_{GS} = 0$	-	-	1.4	V
Input Capacitance	C_{iss}	$V_{GS} = 0V,$ $V_{DS} = 8V,$ Frequency=1.0MHz	-	522	-	pF
Output Capacitance	C_{oss}		-	98.5	-	pF
Reverse Transfer Capacitance	C_{rss}		-	75	-	pF
Turn-ON Delay Time	$t_{d(on)}$		-	10.5	-	ns
Turn-ON Rise Time	t_r	$V_{DD} = 10V,$ $V_{GS} = 4.5V,$ $R_{GEN} = 3\Omega,$ $I_D = 6A$	-	4.5	-	ns
Turn-OFF Delay Time	$t_{d(off)}$		-	27.5	-	ns
Turn-ON Fall Time	t_f		-	4	-	ns
Total Gate Charge	Q_g		$V_{DS} = 10V,$	-	6.5	-
Gate-Source Charge	Q_{gs}	$V_{GS} = 4.5V,$	-	1.5	-	nC
Gate-Drain Charge	Q_{gd}	$I_D = 6A$	-	1.3	-	nC

Note 3: Product parametric performance is indicated in the Electrical Characteristics for the listed test conditions, unless otherwise noted. Product performance may not be indicated by the Electrical Characteristics if operated under different conditions.



7. Typical electrical and thermal characteristics

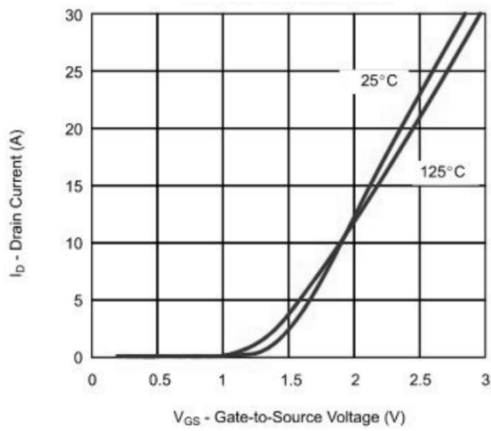

Transfer Characteristics

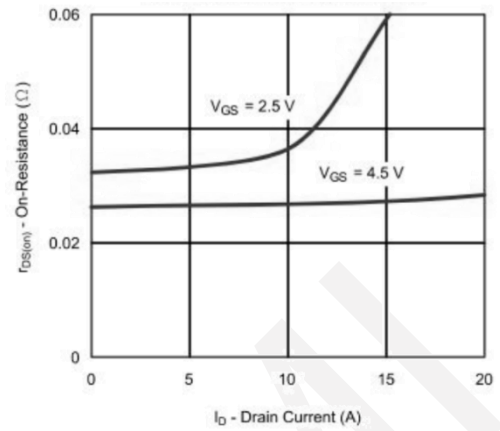

On-Resistance vs. Drain Current

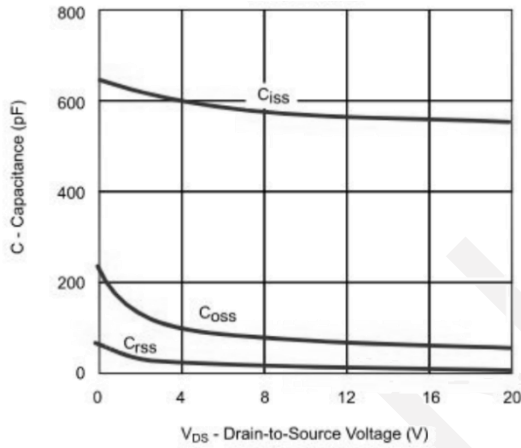

Capacitance

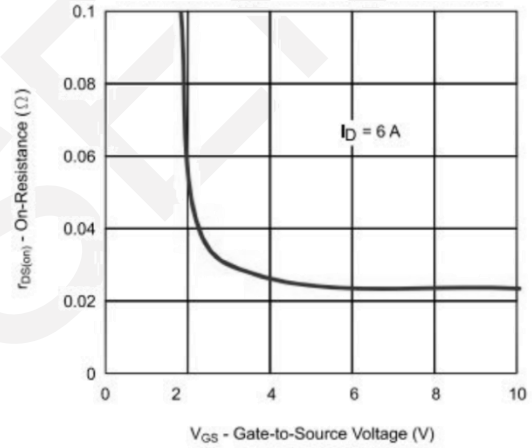

On-Resistance vs. Gate-to-Source Voltage

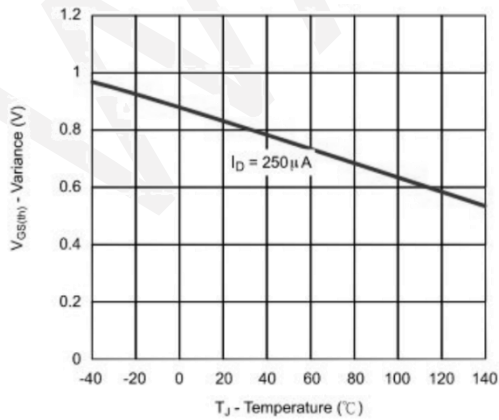

Threshold Voltage

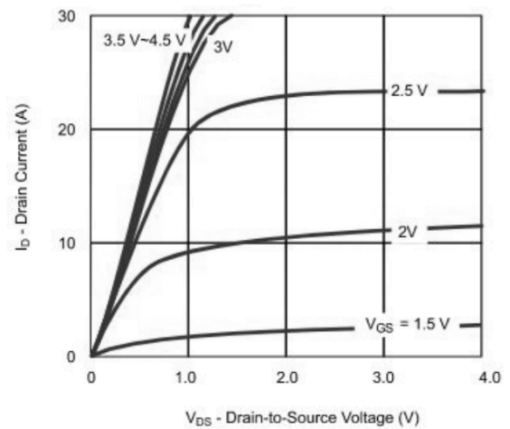

On-Region Characteristics

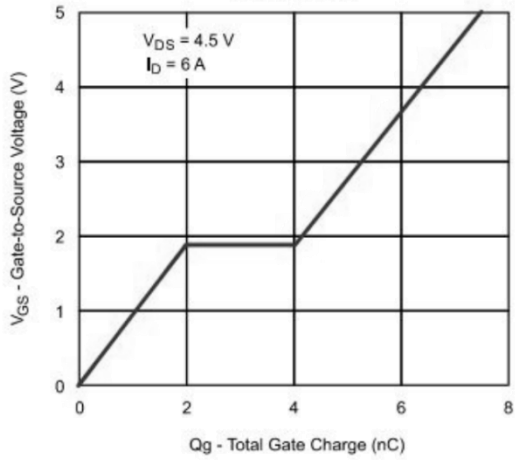

Gate Charge

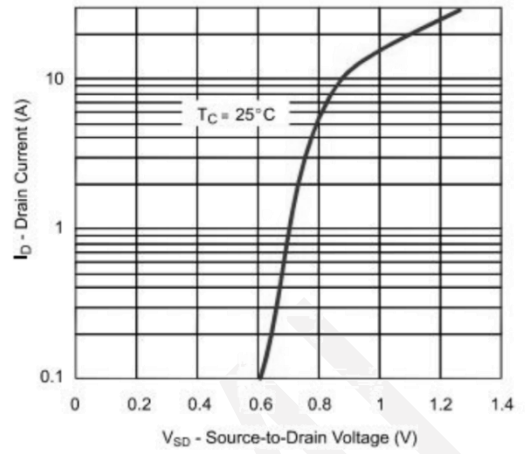

On-Resistance vs. Drain Current

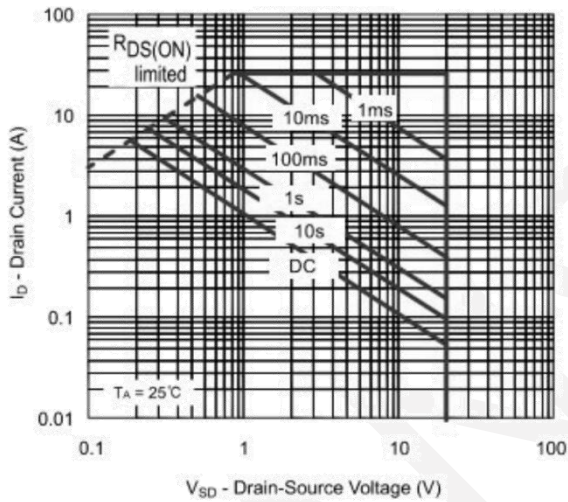

Maximum Forward Biased Safe Operating Area

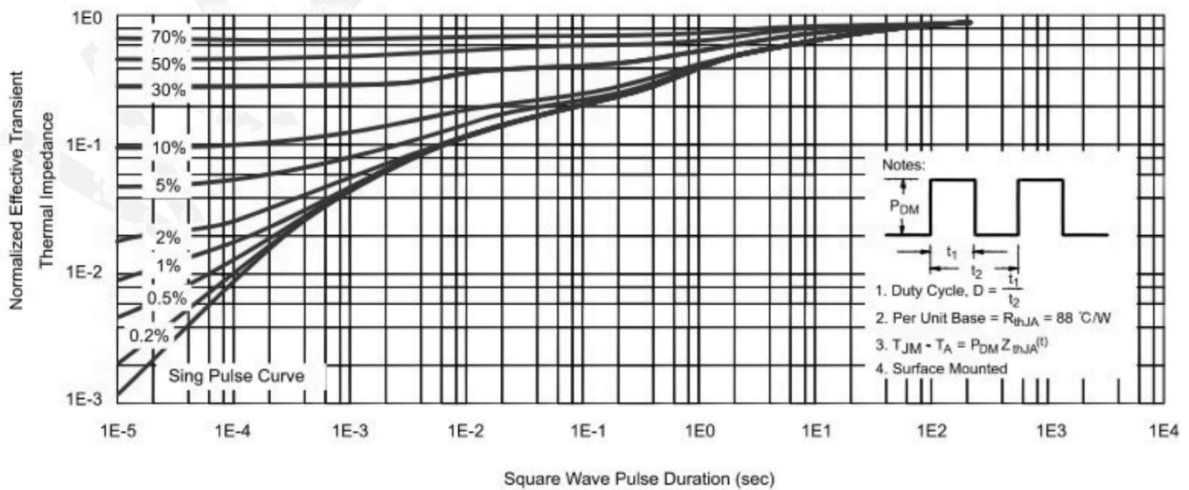

Normalized Thermal Transient Impedance, Junction-to-Ambient



8.Package Dimensions

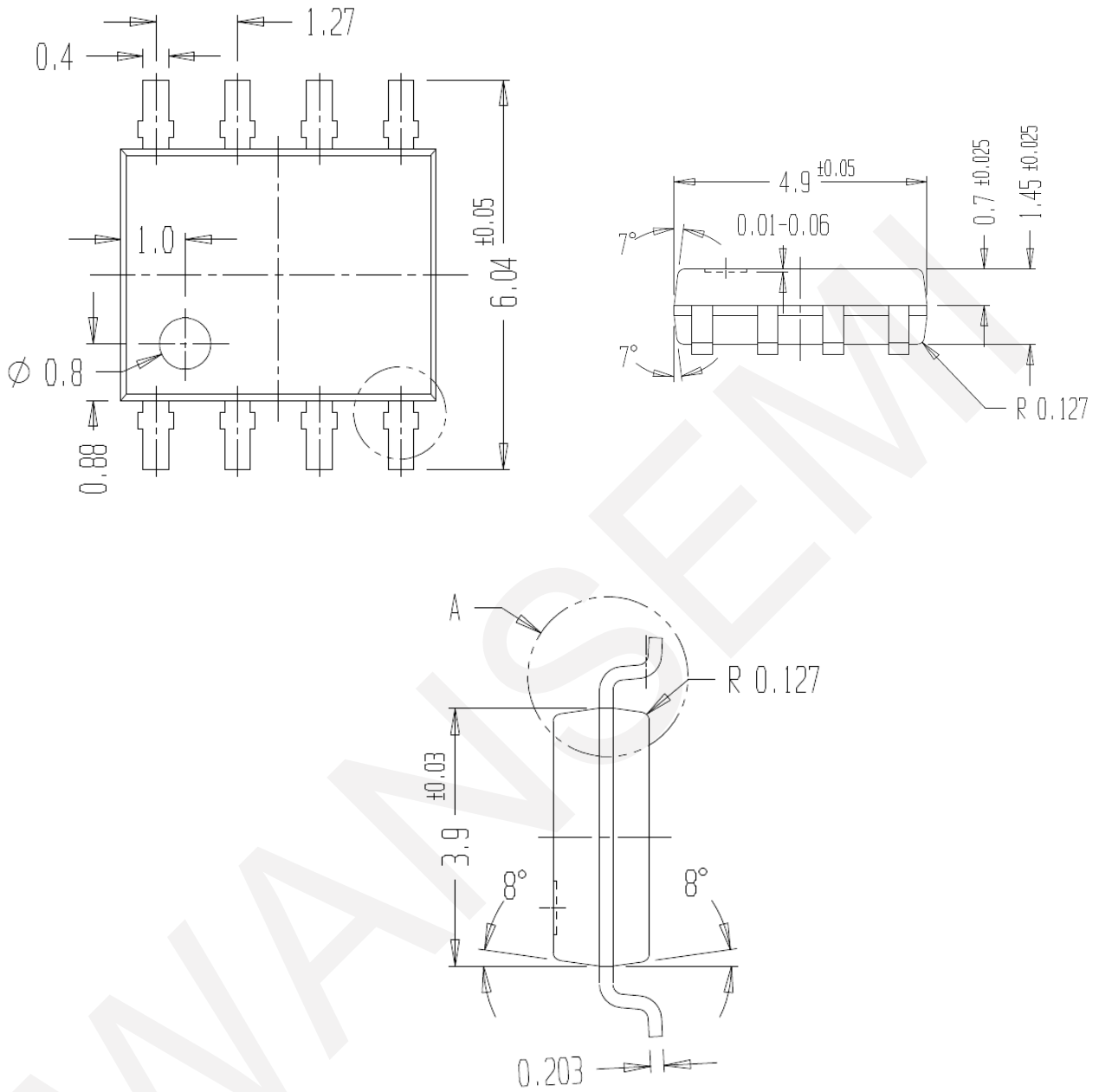

9. Important Notice

WAN SEMICONDUCTOR (NINGBO) CO.,LTD reserves the right to make corrections, enhancements, improvements and other changes to its semiconductor products and services and to discontinue any product or service. Buyers should obtain the latest relevant information before placing orders and should verify that such information is current and complete. All semiconductor products (also referred to herein as “components”) are sold subject to WANSEMI’s terms and conditions of sale supplied at the time of order acknowledgment.

WANSEMI warrants performance of its components to the specifications applicable at the time of sale, in accordance with the warranty in WANSEMI’s terms and conditions of sale of semiconductor products. Testing and other quality control techniques are used to the extent WANSEMI deems necessary to support this warranty. Except where mandated by applicable law, testing of all parameters of each component is not necessarily performed.

WANSEMI assumes no liability for applications assistance or the design of Buyers’ products. Buyers are responsible for their products and applications using WANSEMI components. To minimize the risks associated with Buyers’ products and applications, Buyers should provide adequate design and operating safeguards.

No WANSEMI components are authorized for use in FDA Class III (or similar life-critical medical equipment) unless authorized officers of the parties have executed a special agreement specifically governing such use.

Unless WANSEMI has specifically designated certain components which meet ISO/TS16949 requirements, mainly for automotive use, WANSEMI will not be responsible for any failure of such components to meet such requirements.