



**WANSEMI**  
万芯半导体

**WP4N65FA**

# Enhancement Mode N-Channel Power MOSFET

TO-220F/NMOS/650V/ $\pm 30$ V/3V/4A/2.25 $\Omega$

Rev0.7

---

## 650V, 2.25Ω, 4A, N-Channel MOSFET

### 1. Features

- ◆ New technology for high voltage device
- ◆ Low on-resistance and low conduction losses
- ◆ Ultra Low Gate Charge cause lower driving requirements

V <sub>DS</sub> Typ.	R <sub>DS(on)</sub> Typ.	I <sub>D</sub> Max.
650V	2.25Ω @ 10V	4A

### 2. Applications

- ◆ Power factor correction
- ◆ Switched mode power supplies
- ◆ Uninterruptible Power Supply

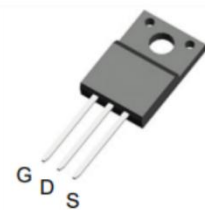

Pin Description  
TO-220F

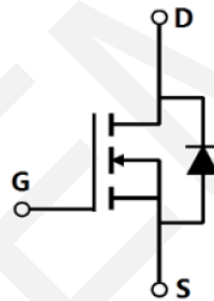

Schematic Diagram

### 3. Package Marking and Ordering Information

Part no.	Marking	Package	PCS/Tube	PCS/CTN.
WP4N65FA	WP4N65	TO-220F	50	5,000

### 4. Absolute Max Ratings at Ta=25°C (Note1)

Parameter	Symbol	Maximum	Units
Drain to Source Voltage	V <sub>DSS</sub>	650	V
Gate to Source Voltage	V <sub>GSS</sub>	±30	V
Drain Current-Continuous	I <sub>D</sub>	4	A
Drain Current (Pulse)	I <sub>DM</sub>	16	A
Single Pulsed Avalanche Energy	E <sub>AS</sub>	210	mJ
Maximum Power Dissipation	P <sub>D</sub>	28.4	W
Operating Junction and Storage Temperature Range	T <sub>j</sub> , T <sub>stg</sub>	-55 to +160	°C

Note 1: Stresses exceeding those listed in the Maximum Ratings table may damage the device. If any of these limits are exceeded, device functionality should not be assumed, damage may occur and reliability may be affected.

**5. Thermal Resistance Ratings (Note 2)**

Parameter	Symbol	Value	Unit
Thermal Resistance, Junction to Case	$R_{\theta JC}$	4.4	$^{\circ}C/W$

Note 2: When mounted on 1 inch square copper board  $t \leq 10$ sec The value in any given application depends on the user's specific board design.

**6. Electrical Characteristics at  $T_a=25^{\circ}C$  (Note 3)**

Parameter	Symbol	Test Conditions	Min.	Typ.	Max.	Units
Drain to Source Breakdown Voltage	$V_{(BR)DSS}$	$I_D = 250\mu A, V_{GS} = 0V$	650	700	-	V
Zero-Gate Voltage Drain Current	$I_{DSS}$	$V_{DS} = 650V, V_{GS} = 0V$	-	-	1	$\mu A$
Gate-Body Leakage Current	$I_{GSS}$	$V_{GS} = \pm 30V, V_{DS} = 0V$	-	-	$\pm 100$	nA
Gate Threshold Voltage	$V_{GS(th)}$	$V_{DS}=V_{GS}, I_{DS}=250\mu A$	2	3	4	V
Drain to Source On-State Resistance	$R_{DS(on)}$	$I_D = 2A, V_{GS} = 10V$	-	2.25	2.5	$\Omega$
Input Capacitance	$C_{iss}$	$V_{GS}=0V,$ $V_{DS}=50V,$ Frequency=1.0MHz	-	304	-	pF
Output Capacitance	$C_{oss}$		-	18	-	pF
Reverse Transfer Capacitance	$C_{rss}$		-	0.6	-	pF
Turn-ON Delay Time	$t_{d(on)}$	$V_{DD} = 380V, V_{GS} = 10V, R_{GEN} = 5\Omega, I_D = 2.5A$	-	8	-	ns
Turn-ON Rise Time	$t_r$		-	4	-	ns
Turn-OFF Delay Time	$t_{d(off)}$		-	52	-	ns
Turn-ON Fall Time	$t_f$		-	9	-	ns
Total Gate Charge	$Q_g$		$V_{DS} = 480V,$ $V_{GS} = 10V,$ $I_D = 4A$	-	8.8	-
Gate-Source Charge	$Q_{gs}$	-		2.3	-	nC
Gate-Drain Charge	$Q_{gd}$	-		4	-	nC
Diode Forward Voltage	$V_{SD}$	$I_S = 4A, V_{GS} = 0V$	0.5	0.8	1.1	V
Maximum Continuous Drain to Source Diode Forward Current	$I_S$	-	-	-	4	A
Maximum Pulsed Drain to Source Diode Forward Current	$I_{SM}$	-	-	-	16	A
Body Diode Reverse Recovery Time	$t_{rr}$	$I_F=2A,$ $di/dt=100A/\mu s$	-	200	-	nS
Body Diode Reverse Recovery Chrg	$Q_{rr}$		-	0.6	-	nC

Note 3: Product parametric performance is indicated in the Electrical Characteristics for the listed test conditions, unless otherwise noted. Product performance may not be indicated by the Electrical Characteristics if operated under different conditions.



### 7. Typical electrical and thermal characteristics

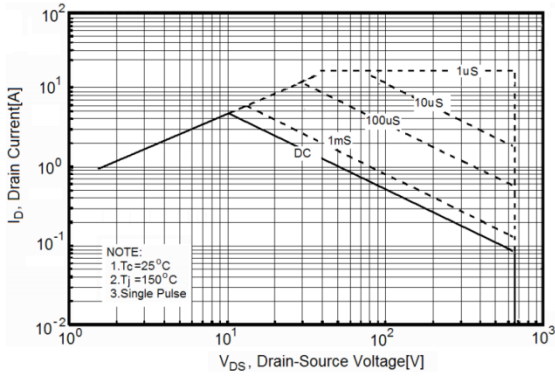

Safe operating area

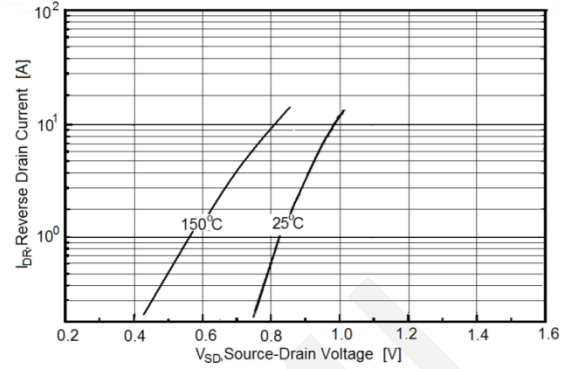

Source-Drain Diode Forward Voltage

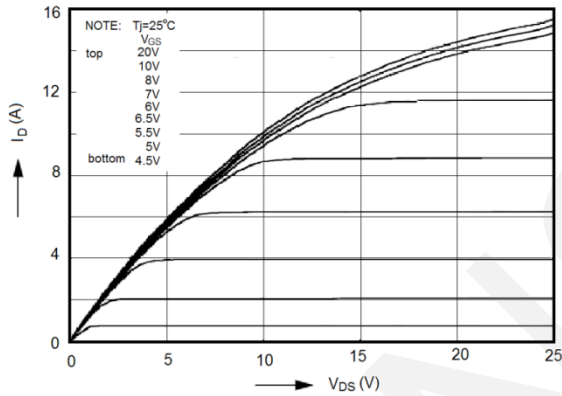

Output Characteristics

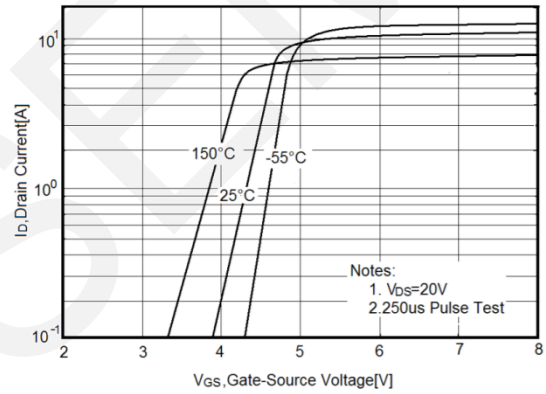

Typical Transfer Characteristics

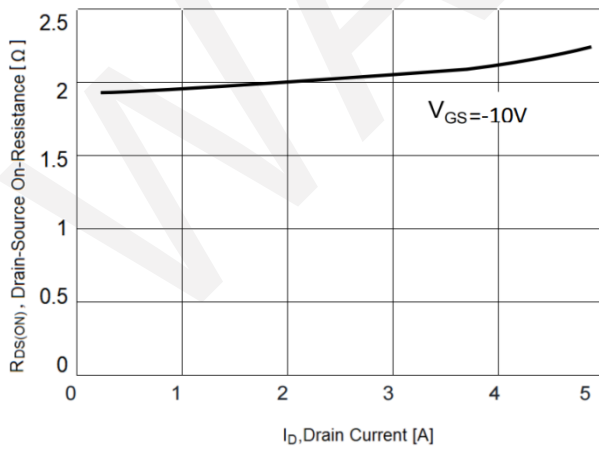

Static drain-source on resistance

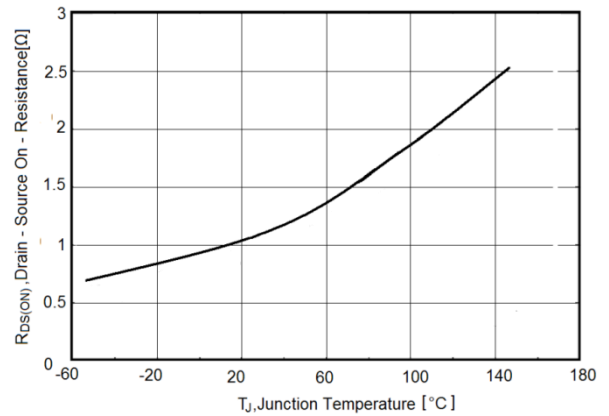

$R_{DS(on)}$  vs Junction Temperature

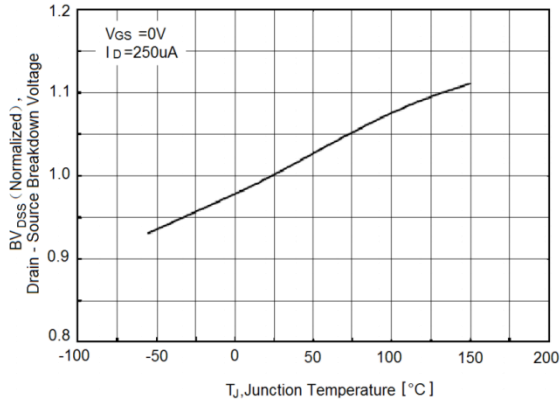

**BV<sub>DSS</sub> vs Junction Temperature**

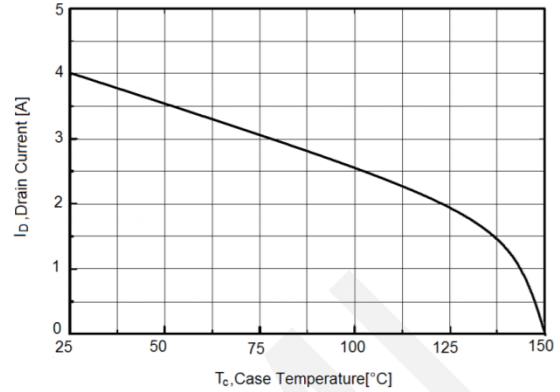

**Maximum Id vs Junction Temperature**

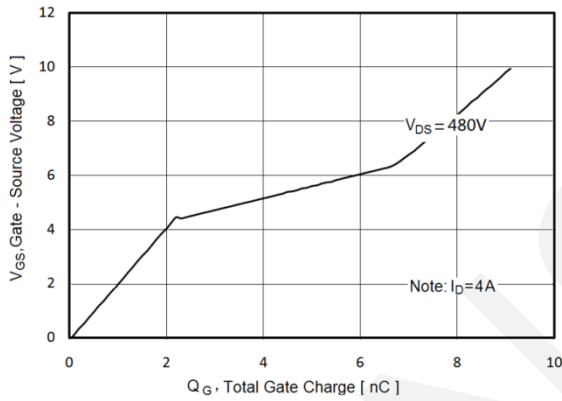

**Gate charge waveforms**

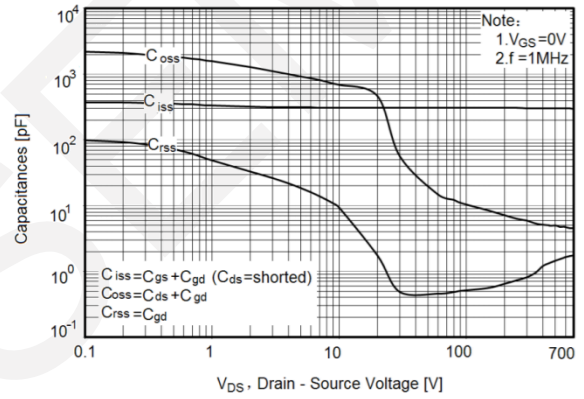

**Capacitance**

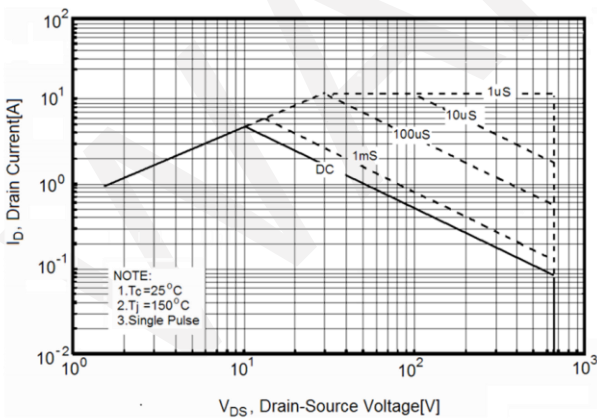

**Safe operating area**

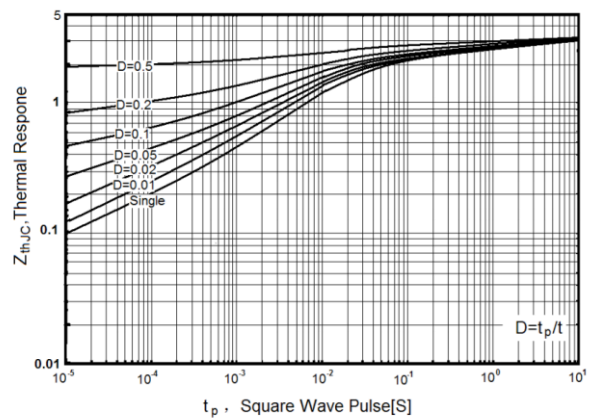

**Transient Thermal Impedance**



**8.Package Dimensions**

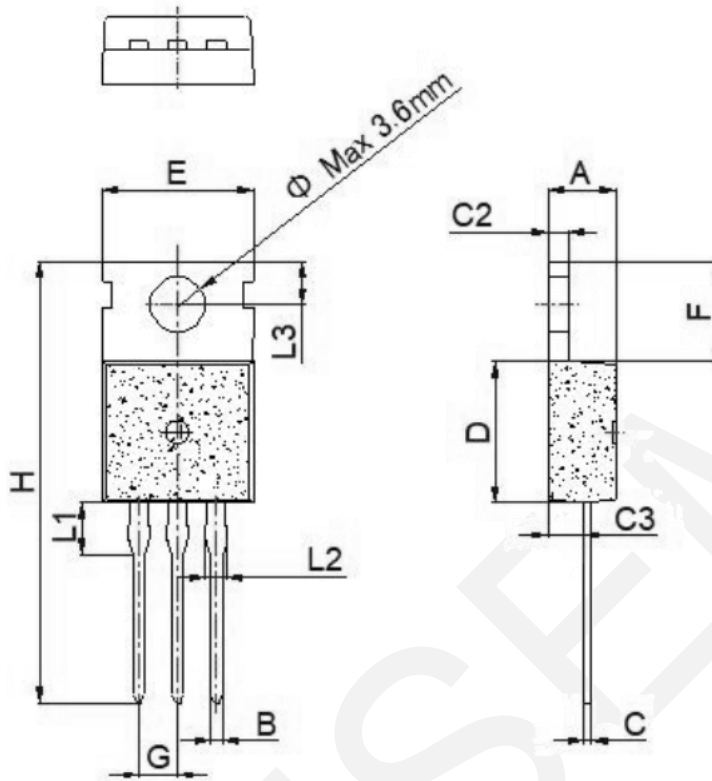

Ref.	Dimensions					
	Millimeters			Inches		
	Min.	Typ.	Max.	Min.	Typ.	Max.
A	4.40		4.60	0.173		0.181
B	0.70		0.90	0.028		0.035
C	0.45		0.60	0.018		0.024
C2	1.23		1.32	0.048		0.052
C3	2.20		2.60	0.087		0.102
D	8.90		9.90	0.350		0.390
E	9.90		10.3	0.390		0.406
F	6.30		6.90	0.248		0.272
G		2.54			0.1	
H	28.0		29.8	1.102		1.173
L1		3.39			0.133	
L2	1.14		1.70	0.045		0.067
L3	2.65		2.95	0.104		0.116
$\Phi$		3.6			0.142	

## 9. Important Notice

WAN SEMICONDUCTOR (NINGBO) CO.,LTD reserves the right to make corrections, enhancements, improvements and other changes to its semiconductor products and services and to discontinue any product or service. Buyers should obtain the latest relevant information before placing orders and should verify that such information is current and complete. All semiconductor products (also referred to herein as “components”) are sold subject to WANSEMI’s terms and conditions of sale supplied at the time of order acknowledgment.

WANSEMI warrants performance of its components to the specifications applicable at the time of sale, in accordance with the warranty in WANSEMI’s terms and conditions of sale of semiconductor products. Testing and other quality control techniques are used to the extent WANSEMI deems necessary to support this warranty. Except where mandated by applicable law, testing of all parameters of each component is not necessarily performed.

WANSEMI assumes no liability for applications assistance or the design of Buyers’ products. Buyers are responsible for their products and applications using WANSEMI components. To minimize the risks associated with Buyers’ products and applications, Buyers should provide adequate design and operating safeguards.

No WANSEMI components are authorized for use in FDA Class III (or similar life-critical medical equipment) unless authorized officers of the parties have executed a special agreement specifically governing such use.

Unless WANSEMI has specifically designated certain components which meet ISO/TS16949 requirements, mainly for automotive use, WANSEMI will not be responsible for any failure of such components to meet such requirements.