



WANSEMI
万芯半导体

WP3025

Enhancement Mode N+P-Channel Power MOSFET

TO-252-4L/N+PMOS/30V/ \pm 20V/1.8V/25A/7.8m Ω

-30V/ \pm 20V/-1.5V/-19A/13.5m Ω

Rev0.7

30V N+P-Channel MOSFET

1.Features

- ◆ High power and current handling capability
- ◆ Lead free product is acquired
- ◆ Fast switching
- ◆ Surface mount package

2.Applications

- ◆ DC motor
- ◆ PWM applications

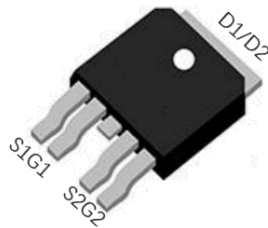

TO-252-4L
Pin Description

◆ N-Channel

V_{DS}	$R_{DS(on)}$ Typ.	I_D
30V	7.8m Ω @10V	25A
	11.9m Ω @ 4.5V	

◆ P-Channel

V_{DS}	$R_{DS(on)}$ Typ.	I_D
-30V	13.5m Ω @ -10V	-19A
	17.5m Ω @ -4.5V	

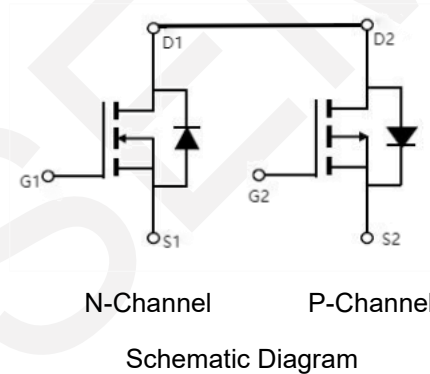

3.Package Marking and Ordering Information

Part no.	Marking	Package	PCS/Reel	PCS/CTN.
WP3025	WP3025	TO-252-4L	2,500	25,000

4.Absolute Max Ratings at Ta=25°C (Note1)

Parameter	Symbol	N-channel	P-channel	Units
Drain to Source Voltage	V_{DSS}	30	-30	V
Gate to Source Voltage	V_{GSS}	± 20	± 20	V
Drain Current (DC)	I_D	25	-19	A
Drain Current (Pulse), $PW \leq 300\mu s$	I_{DM}	90	-60	A
Total Dissipation	P_D	21		W
Junction Temperature	T_j	-55 to +175		$^{\circ}C$
Storage Temperature	T_{stg}			

Note 1: Stresses exceeding those listed in the Maximum Ratings table may damage the device. If any of these limits are exceeded, device functionality should not be assumed, damage may occur and reliability may be affected.

5. Thermal Resistance Ratings (Note 2)

Parameter	Symbol	N-channel	P-channel	Unit
Maximum Junction-to-Ambient	$R_{\theta JA}$	7	7	$^{\circ}C/W$

Note 2: When mounted on 1 inch square copper board $t \leq 10$ sec The value in any given application depends on the user's specific board design.

6. Electrical Characteristics at $T_a=25^{\circ}C$ (Note 3)
N-Channel

Parameter	Symbol	Test Conditions	Min.	Typ.	Max.	Units
Drain to Source Breakdown Voltage	$V_{(BR)DSS}$	$I_D = 250\mu A, V_{GS} = 0V$	30	-	-	V
Zero-Gate Voltage Drain Current	I_{DSS}	$V_{DS} = 30V, V_{GS} = 0V$	-	-	1	μA
Gate to Source Leakage Current	I_{GSS}	$V_{GS} = \pm 20V, V_{DS} = 0V$	-	-	± 100	nA
Gate Threshold Voltage	$V_{GS(th)}$	$V_{DS}=V_{GS}, I_{DS}=250\mu A$	1.0	1.8	3.0	V
Static Drain to Source On-State Resistance	$R_{DS(on)}$	$I_D = 7A, V_{GS} = 10V$	-	7.8	12	m Ω
		$I_D = 6A, V_{GS} = 4.5V$	-	11.9	18	m Ω
Input Capacitance	C_{iss}	$V_{GS}=0V,$ $V_{DS}=15V,$ Frequency=1.0MHz	-	450	-	pF
Output Capacitance	C_{oss}		-	150	-	pF
Reverse Transfer Capacitance	C_{rss}		-	90	-	pF
Turn-ON Delay Time	$t_{d(on)}$	$V_{DD} = 15V$ $V_{GS} = 10V$ $R_G = 3\Omega$ $R_L = 2.5\Omega$	-	5	-	ns
Rise Time	t_r		-	12	-	ns
Turn-OFF Delay Time	$t_{d(off)}$		-	19	-	ns
Fall Time	t_f		-	6	-	ns
Total Gate Charge	Q_g	$V_{DS} = 15V,$	-	9.5	-	nC
	Q_{gs}	$V_{GS} = 10V,$	-	2	-	nC
	Q_{gd}	$I_D = 6A$	-	1.9	-	nC
Diode Forward Voltage	V_{FSD}	$I_S = 7A, V_{GS} = 0V$	-	-	1.2	V

P-Channel

Note 3: Product parametric performance is indicated in the Electrical Characteristics for the listed test

Parameter	Symbol	Test Conditions	Min.	Typ.	Max.	Units
Drain to Source Breakdown Voltage	$V_{(BR)DSS}$	$I_D = -250\mu A, V_{GS} = 0V$	-30	-	-	V
Zero-Gate Voltage Drain Current	I_{DSS}	$V_{DS} = -30V, V_{GS} = 0V$	-	-	-1	μA
Gate to Source Leakage Current	I_{GSS}	$V_{GS} = \pm 20V, V_{DS} = 0V$	-	-	± 100	nA
Gate Threshold Voltage	$V_{GS(th)}$	$V_{DS}=V_{GS}, I_{DS}=-250\mu A$	-1.0	-1.5	-2.5	V
Static Drain to Source On-State Resistance	$R_{DS(on)}$	$I_D = -6A, V_{GS} = -10V$	-	13.5	20	m Ω
		$I_D = -5A, V_{GS} = -4.5V$	-	17.5	25	m Ω
Input Capacitance	C_{iss}	$V_{GS}=0V,$ $V_{DS}=-15V,$ Frequency=1.0MHz	-	920	-	pF
Output Capacitance	C_{oss}		-	140	-	pF
Reverse Transfer Capacitance	C_{rss}		-	90	-	pF
Turn-ON Delay Time	$t_{d(on)}$	$V_{DD} = -15V$ $V_{GS} = -10V$ $R_{GEN} = 3\Omega,$ $R_L = 1.5\Omega,$	-	8	-	ns
Rise Time	t_r		-	30	-	ns
Turn-OFF Delay Time	$t_{d(off)}$		-	22	-	ns
Fall Time	t_f		-	26	-	ns
Total Gate Charge	Q_g	$V_{DS} = -15V,$	-	16.2	-	nC
	Q_{gs}	$V_{GS} = -10V,$	-	2.9	-	nC
	Q_{gd}	$I_D = -6A$	-	3.6	-	nC
Diode Forward Voltage	V_{FSD}	$I_S = -6A, V_{GS} = 0V$	-	-	-1.2	V

conditions, unless otherwise noted. Product performance may not be indicated by the Electrical Characteristics if operated under different conditions.



7. Typical electrical and thermal characteristics

N-Channel

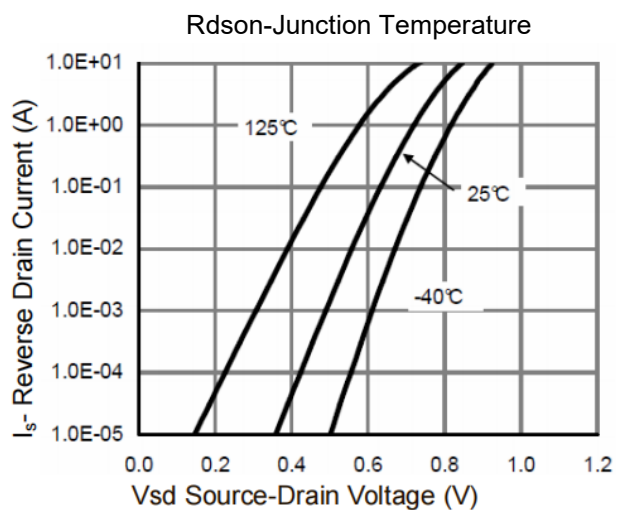
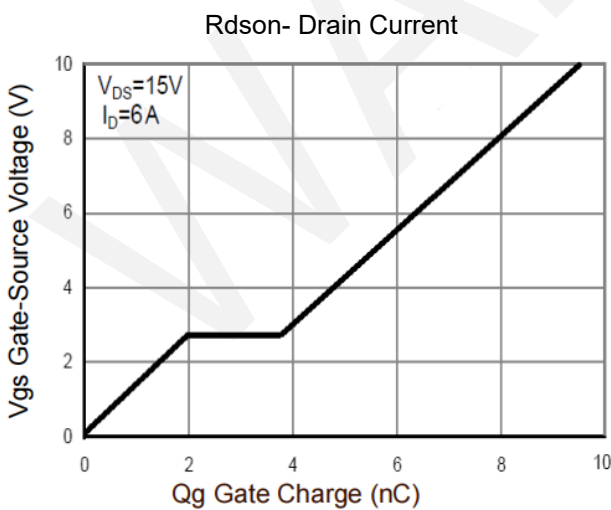
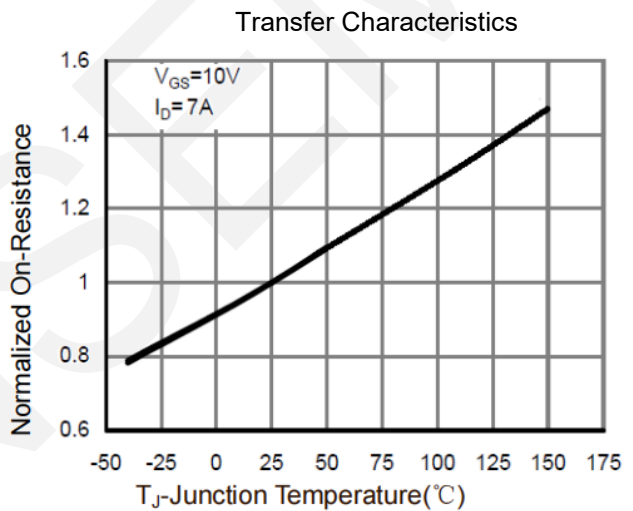
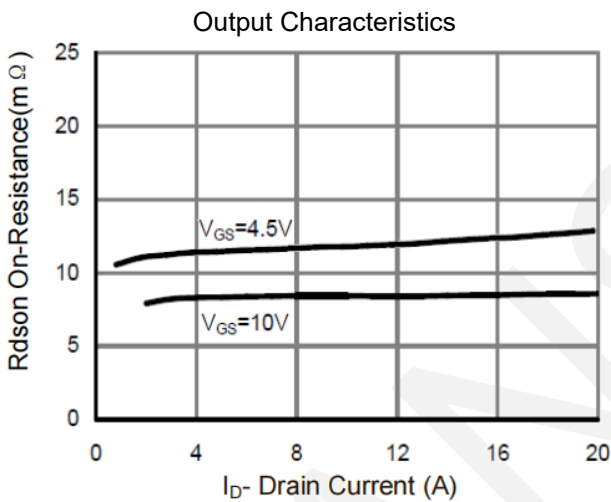
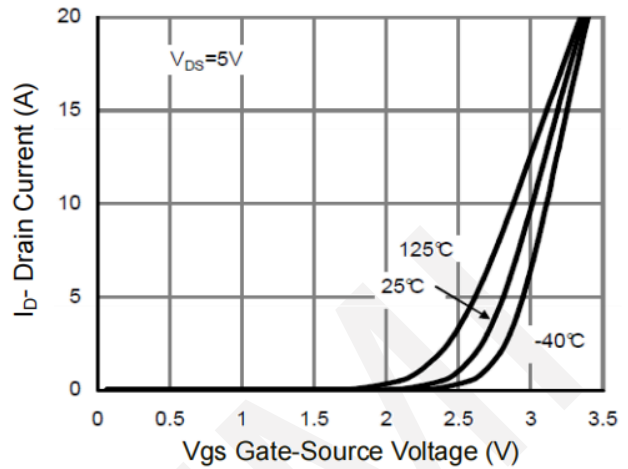
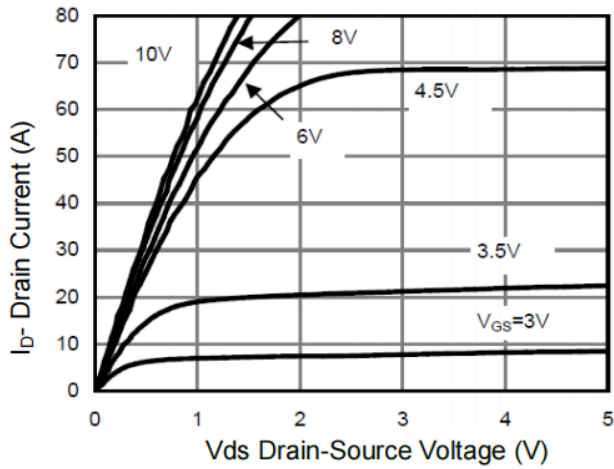

Gate Charge

Source- Drain Diode Forward

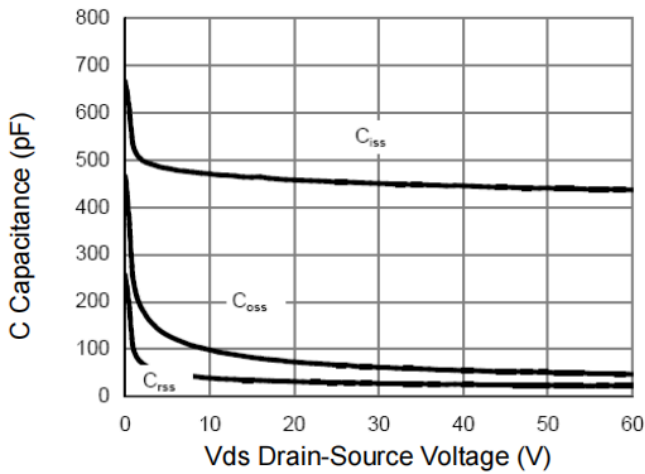

Capacitance vs Vds

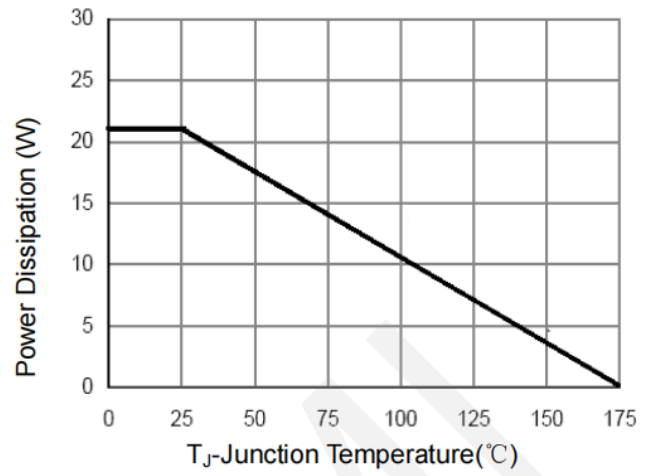

Power De-rating

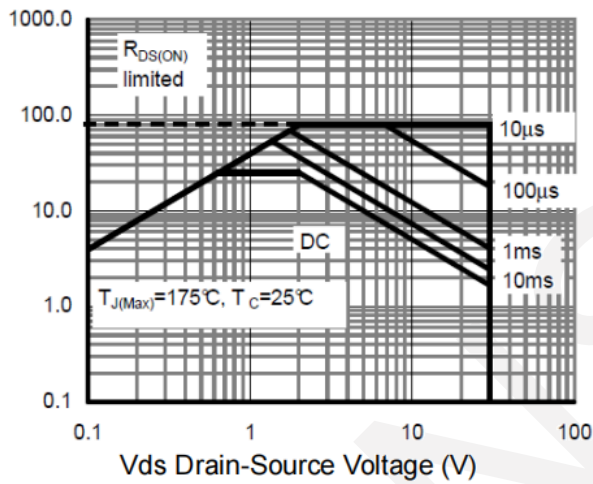

Safe Operation Area

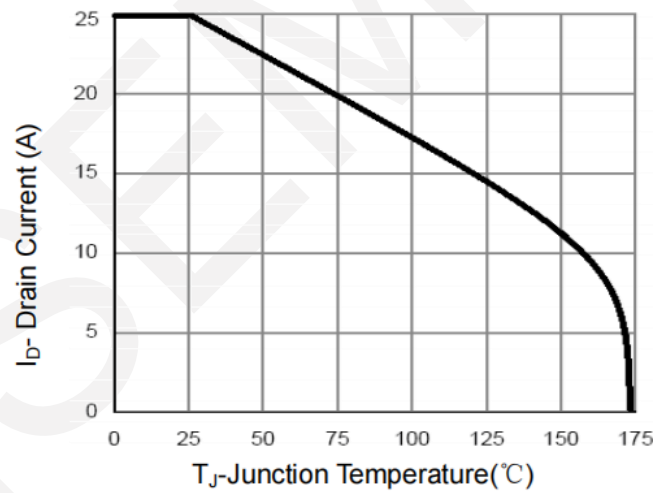

Current De-rating



P-Channel

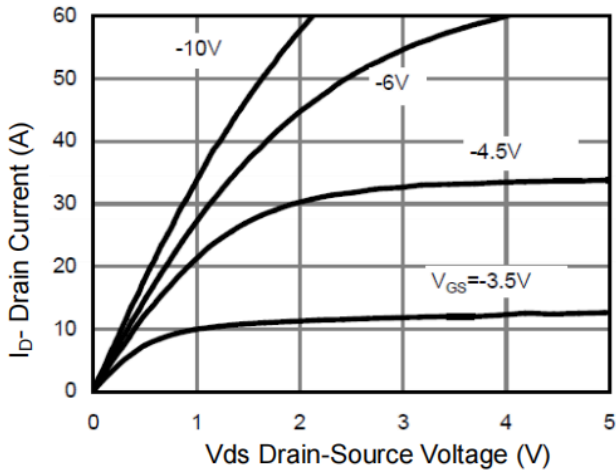

Output Characteristics

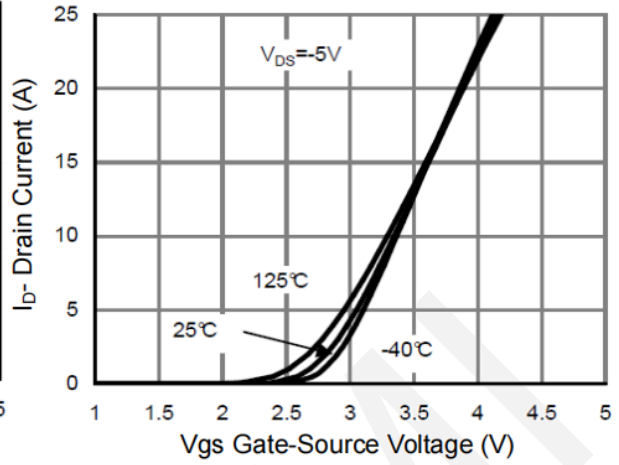

Transfer Characteristics

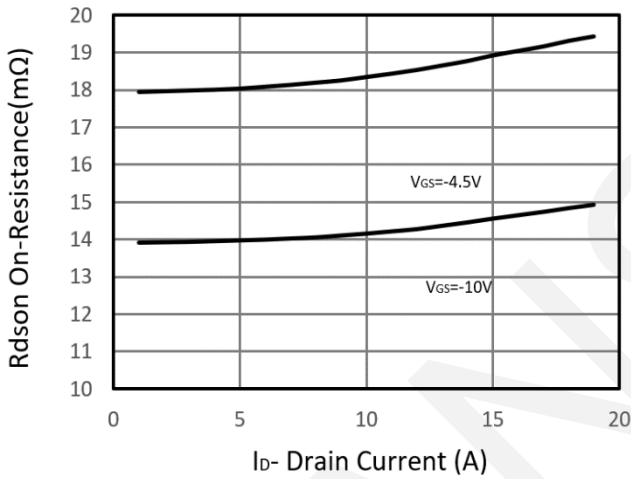

Rdson- Drain Current

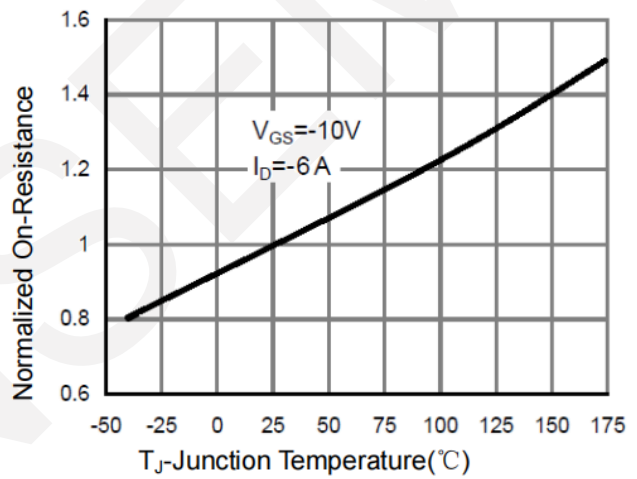

Rdson-Junction Temperature

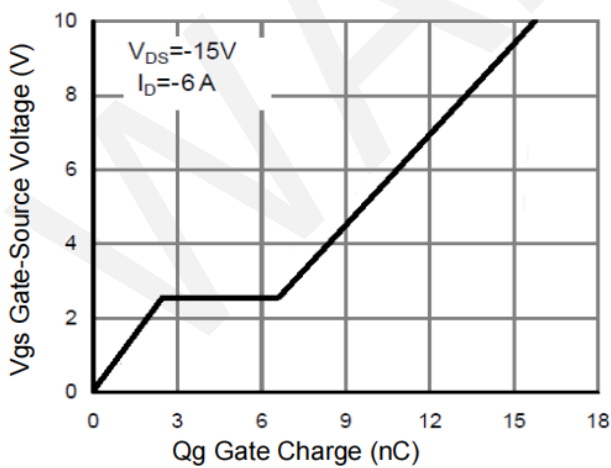

Gate Charge

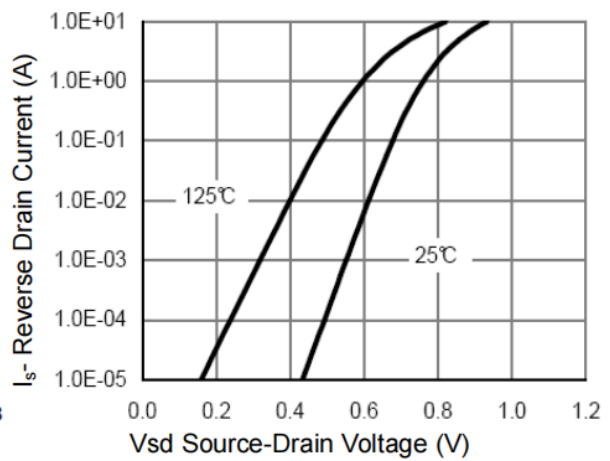

Source- Drain Diode Forward

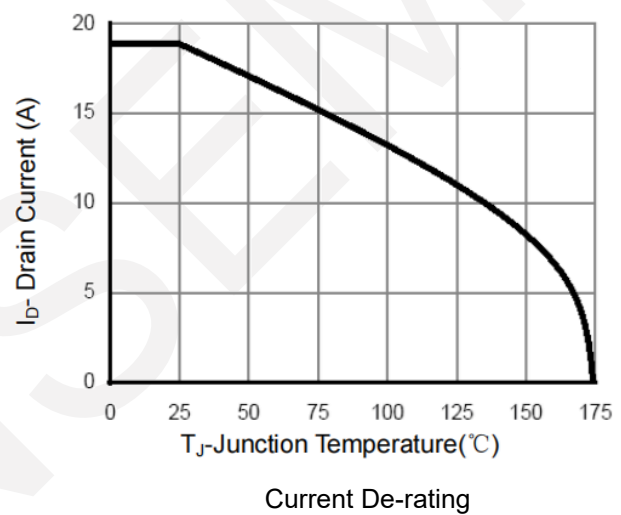
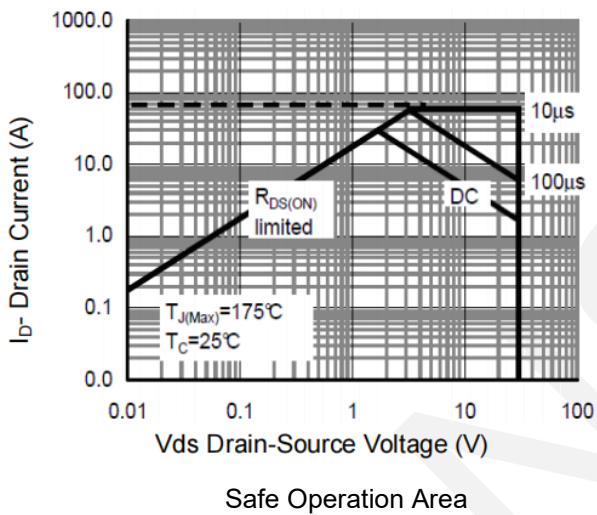
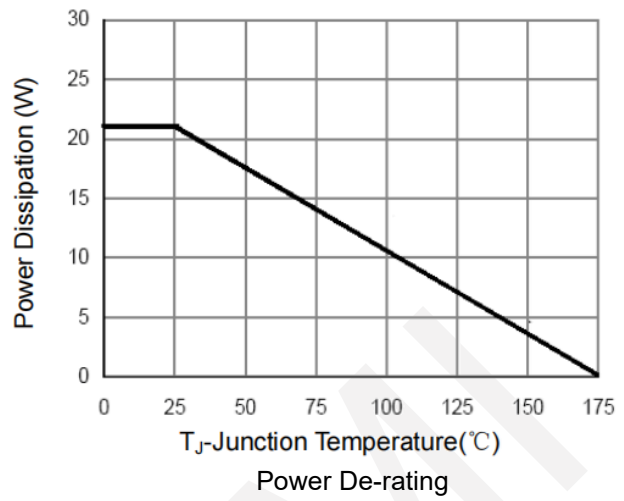
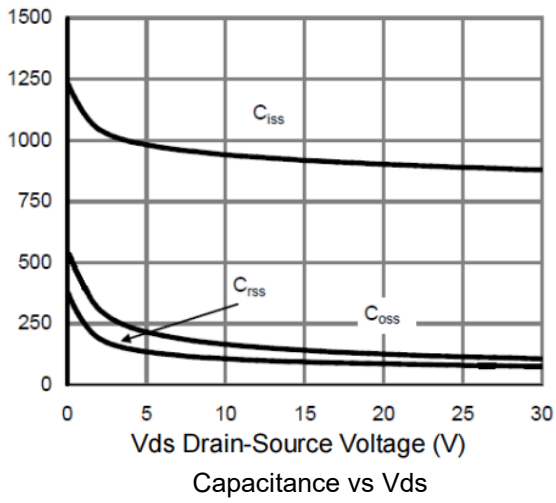



8.Package Dimensions

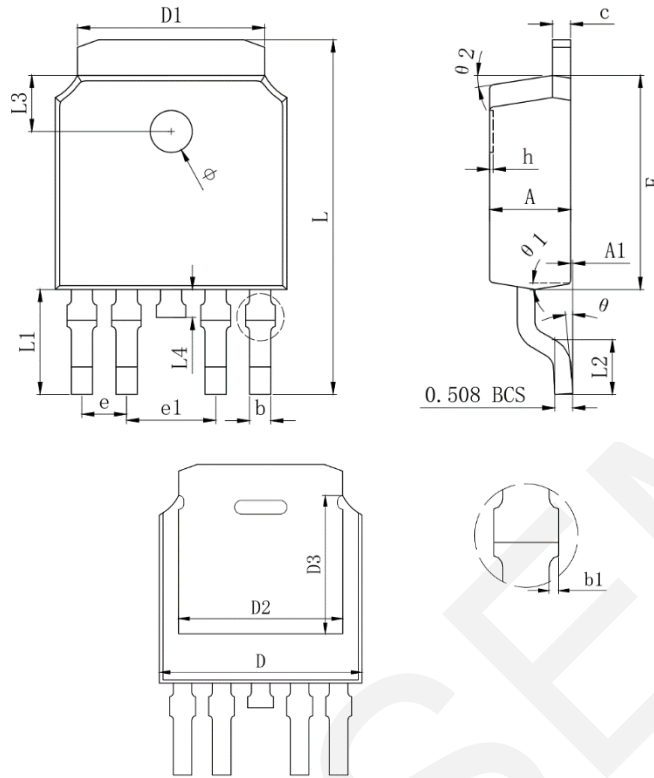

SYMBOL	MILLIMETER		
	MIN	Typ.	MAX
A	2.200	2.300	2.400
A1	0.000		0.127
b	0.550	0.600	0.650
b1	0.000		0.120
c(电镀后)	0.460	0.520	0.580
D	6.500	6.600	6.700
D1	5.334 REF		
D2	5.346 REF		
D3	4.490 REF		
E	6.000	6.100	6.200
e	1.270 TYP		
e1	2.540 TYP		
h	0.000	0.100	0.200
L	9.900	10.100	10.300
L1	2.988 REF		
L2	1.400	1.550	1.700
L3	1.600 REF		
L4	0.700	0.800	0.900
Φ	1.100	1.200	1.300
θ	0°		8°
θ 1	9° TYP		
θ 2	9° TYP		

9. Important Notice

WAN SEMICONDUCTOR (NINGBO) CO.,LTD reserves the right to make corrections, enhancements, improvements and other changes to its semiconductor products and services and to discontinue any product or service. Buyers should obtain the latest relevant information before placing orders and should verify that such information is current and complete. All semiconductor products (also referred to herein as “components”) are sold subject to WANSEMI’s terms and conditions of sale supplied at the time of order acknowledgment.

WANSEMI warrants performance of its components to the specifications applicable at the time of sale, in accordance with the warranty in WANSEMI’s terms and conditions of sale of semiconductor products. Testing and other quality control techniques are used to the extent WANSEMI deems necessary to support this warranty. Except where mandated by applicable law, testing of all parameters of each component is not necessarily performed.

WANSEMI assumes no liability for applications assistance or the design of Buyers’ products. Buyers are responsible for their products and applications using WANSEMI components. To minimize the risks associated with Buyers’ products and applications, Buyers should provide adequate design and operating safeguards.

No WANSEMI components are authorized for use in FDA Class III (or similar life-critical medical equipment) unless authorized officers of the parties have executed a special agreement specifically governing such use.

Unless WANSEMI has specifically designated certain components which meet ISO/TS16949 requirements, mainly for automotive use, WANSEMI will not be responsible for any failure of such components to meet such requirements.