



**WANSEMI**  
万芯半导体

**WP8205C**

# **Enhancement Mode N-Channel Power MOSFET**

SOT23-6/NMOS/16V/ $\pm 12$ V/0.55V/4A/19m $\Omega$

Rev0.8

---

## 16V, 19mΩ, 4A, N-Channel MOSFET

### 1.Features

- ◆ High Power and current handing capability
- ◆ Lead free product is acquired
- ◆ Surface Mount Package

V <sub>DS</sub> Typ.	R <sub>DS(on)</sub> Typ.	I <sub>D</sub> Max.
16V	19mΩ @ 4.5V	4A
	24mΩ @ 2.5V	

### 2.Applications

- ◆ Battery Protection
- ◆ Battery Powered Systems
- ◆ Power Management in Notebook Computer
- ◆ Portable Equipment



Pin Description

SOT23-6

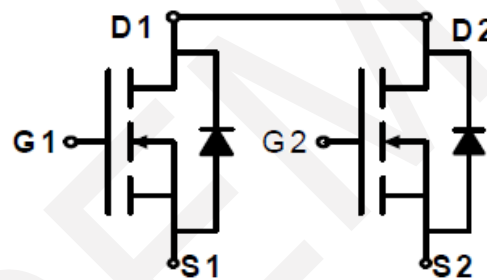

Schematic Diagram

### 3.Package Marking and Ordering Information

Part no.	Marking	Package	PCS/Reel	PCS/CTN.
WP8205C	8205A	SOT23-6	3,000	180,000

### 3.Absolute Max Ratings at Ta=25°C (Note1)

Parameter	Symbol	Maximum	Units
Drain to Source Voltage	V <sub>DSS</sub>	16	V
Gate to Source Voltage	V <sub>GSS</sub>	±12	V
Drain Current-Continuous	I <sub>D</sub>	4	A
Drain Current (Pulse)	I <sub>DM</sub>	30	A
Maximum Power Dissipation	P <sub>D</sub>	1.5	W
Operating Junction and Storage Temperature Range	T <sub>j</sub> , T <sub>stg</sub>	-55 to +150	°C
Lead Temperature for Soldering Purposes (1/8" from case for 10 s)	T <sub>L</sub>	260	°C

Note 1: Stresses exceeding those listed in the Maximum Ratings table may damage the device. If any of these limits are exceeded, device functionality should not be assumed, damage may occur and reliability may be affected.

**4. Electrical Characteristics at Ta=25°C (Note 2)**

Parameter	Symbol	Test Conditions	Min.	Typ.	Max.	Units
Drain to Source Breakdown Voltage	$V_{(BR)DSS}$	$I_D = 250\mu A, V_{GS} = 0V$	16	18	-	V
Zero-Gate Voltage Drain Current	$I_{DSS}$	$V_{DS} = 16V, V_{GS} = 0V$	-	-	1	$\mu A$
Gate-Body Leakage Current	$I_{GSS}$	$V_{GS} = \pm 12V, V_{DS} = 0V$	-	-	$\pm 100$	nA
Gate Threshold Voltage	$V_{GS(th)}$	$V_{DS} = V_{GS}, I_{DS} = 250\mu A$	0.4	0.55	1.2	V
Drain to Source On-State Resistance	$R_{DS(on)}$	$I_D = 4A, V_{GS} = 4.5V$	-	19	24	m $\Omega$
		$I_D = 3A, V_{GS} = 2.5V$	-	24	30	m $\Omega$
Input Capacitance	$C_{iss}$	$V_{GS} = 0V,$ $V_{DS} = 10V,$ Frequency=1.0MHz	-	1150	-	pF
Output Capacitance	$C_{oss}$		-	185	-	pF
Reverse Transfer Capacitance	$C_{rss}$		-	145	-	pF
Turn-ON Delay Time	$t_{d(on)}$	$V_{DD} = 10V, I_D = 4A,$ $V_{GS} = 4.5V, R_{GEN} = 6\Omega$	-	6	-	ns
Turn-ON Rise Time	$t_r$		-	13	-	ns
Turn-OFF Delay Time	$t_{d(off)}$		-	52	-	ns
Turn-ON Fall Time	$t_f$		-	16	-	ns
Total Gate Charge	$Q_g$	$V_{DS} = 10V,$ $V_{GS} = 4.5V,$ $I_D = 4A$	-	15	-	nC
Gate-Source Charge	$Q_{gs}$		-	0.8	-	nC
Gate-Drain Charge	$Q_{gd}$		-	3.2	-	nC
Diode Forward Voltage	$V_{SD}$	$I_S = 4A, V_{GS} = 0V$	-	0.9	1.2	V

Note 2: Product parametric performance is indicated in the Electrical Characteristics for the listed test conditions, unless otherwise noted. Product performance may not be indicated by the Electrical Characteristics if operated under different conditions.



### 5. Typical electrical and thermal characteristics

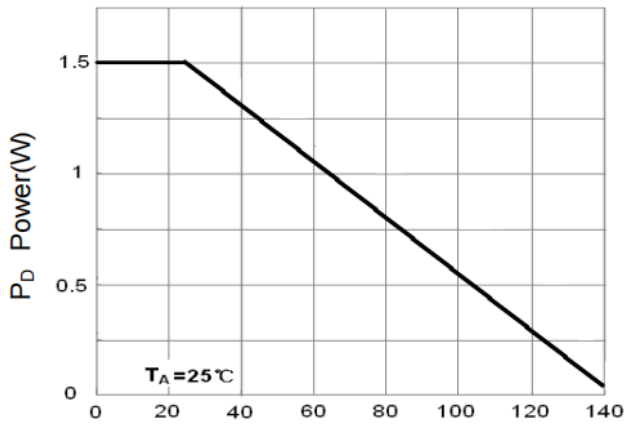

$T_J$ -Junction Temperature( $^{\circ}C$ )  
Power Dissipation

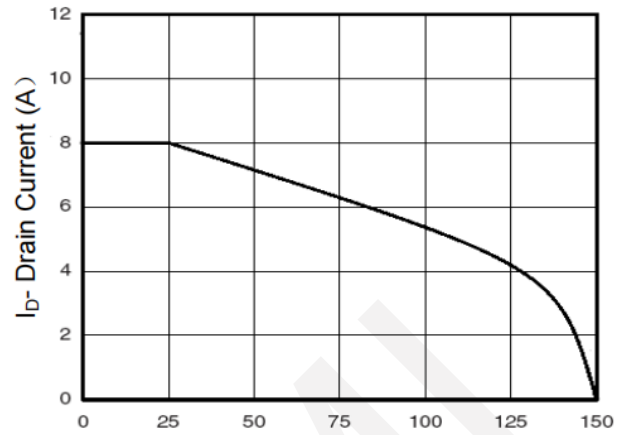

$T_J$ -Junction Temperature( $^{\circ}C$ )  
Drain Current

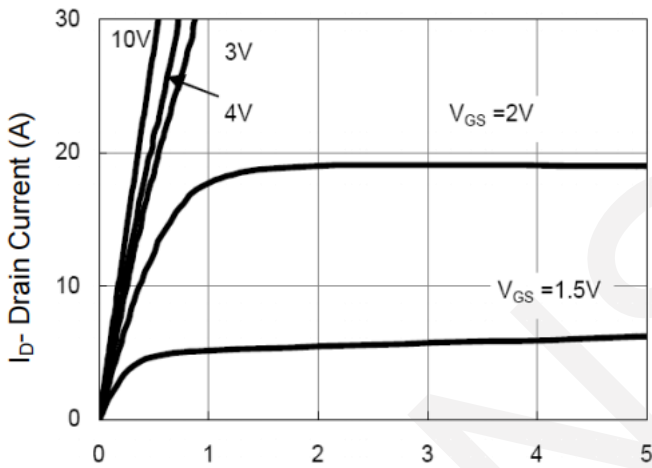

$V_{DS}$  Drain-Source Voltage (V)

Output Characteristics

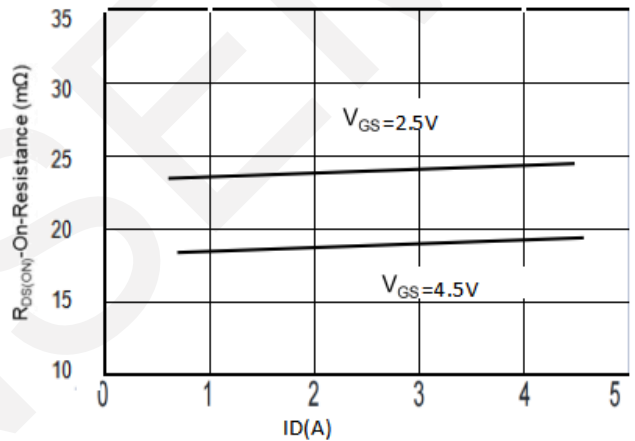

Drain-Source On-Resistance

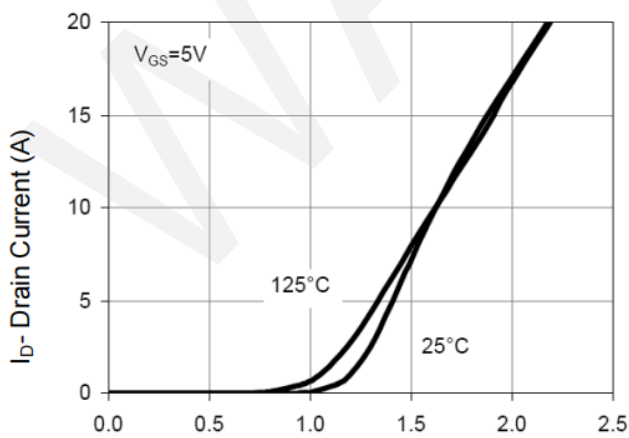

$V_{GS}$  Gate-Source Voltage (V)

Transfer Characteristics

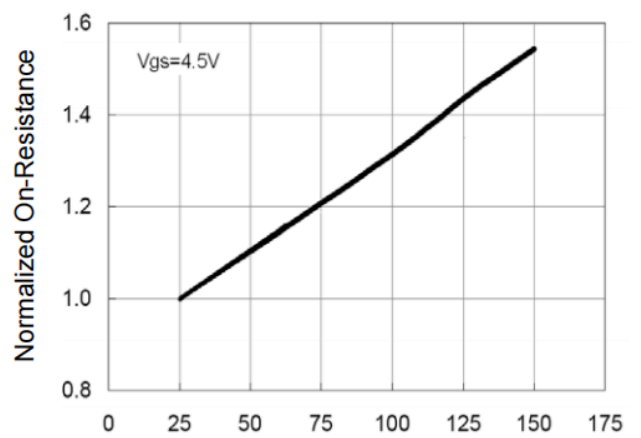

$T_J$ -Junction Temperature( $^{\circ}C$ )

Drain-Source On-Resistance

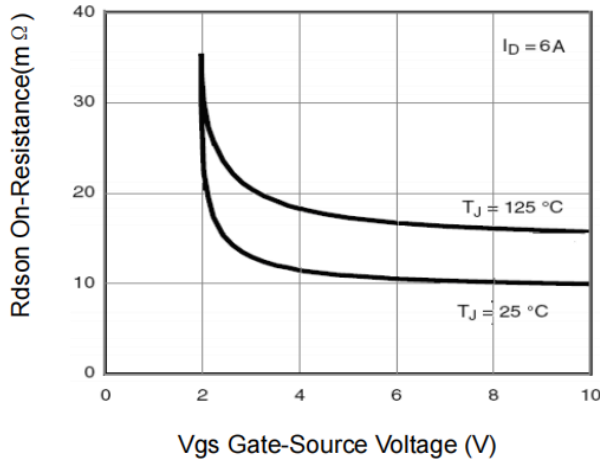

Rdson vs Vgs

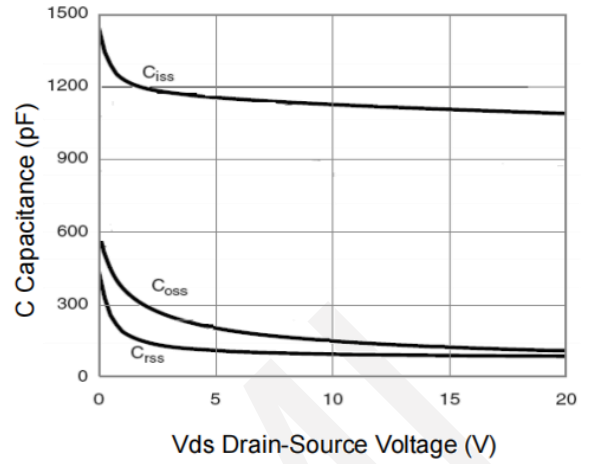

Capacitance vs Vds

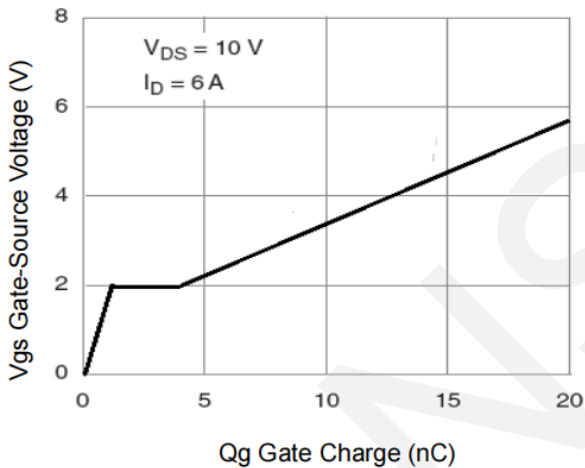

Gate Charge

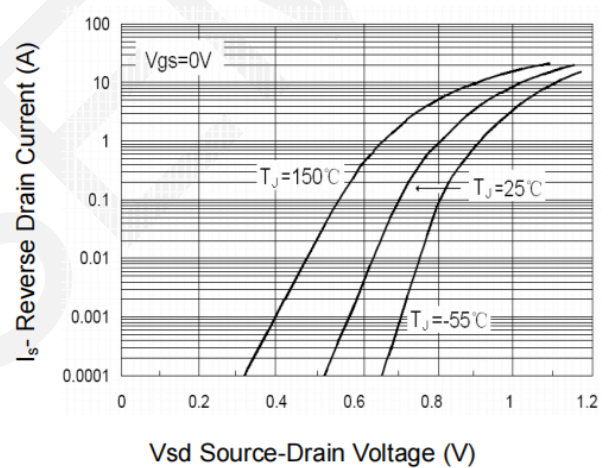

Source-Drain Diode Forward

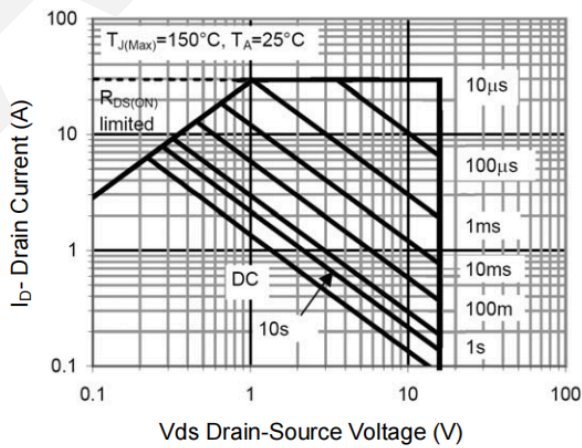

Safe Operation Area

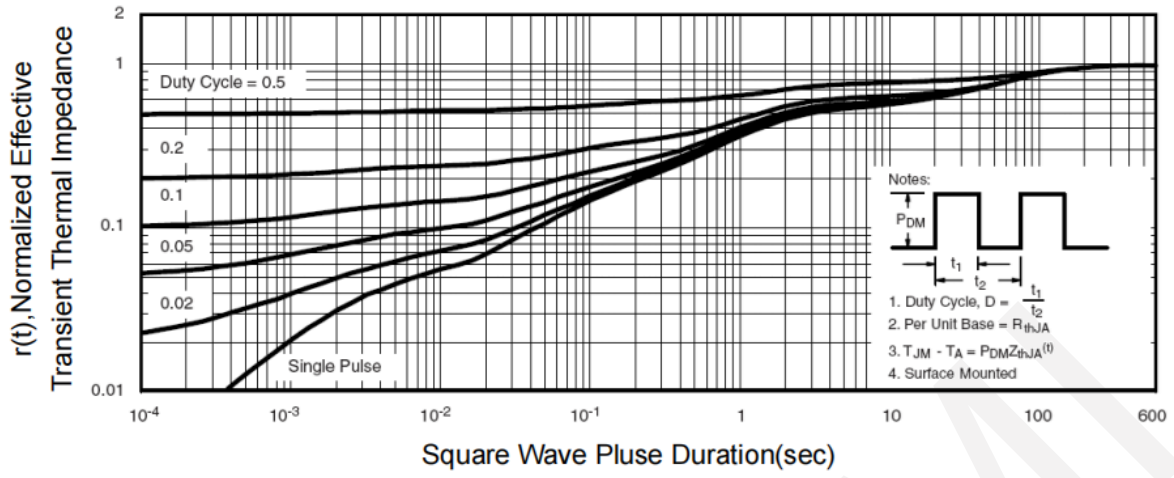

Normalized Maximum Transient Thermal Impedance



**6.Package Dimensions**

**SOT23-6**

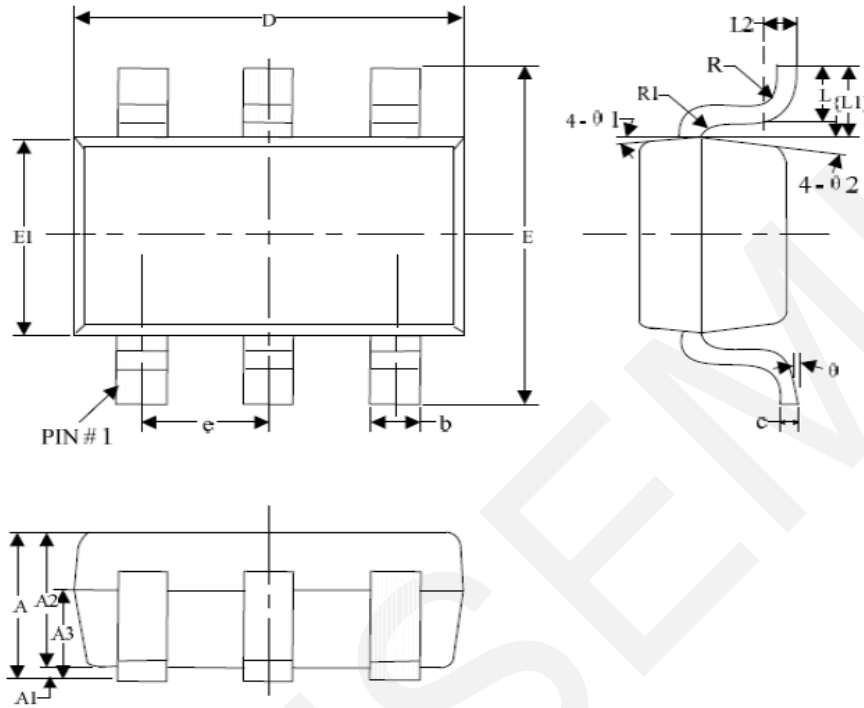

**Dimensions (unit: mm)**

SYMBOL	MIN	NOM	MAX	SYMBOL	MIN	NOM	MAX
A	-	-	1.30	e	0.85	0.95	1.05
A1	0	-	0.15	L	0.35	0.45	0.60
A2	0.90	1.10	1.30	L1	0.59REF		
A3	0.60	0.65	0.70	L2	0.25BSC		
b	0.39	-	0.49	R	0.05	-	-
c	0.12	-	0.19	R1	0.05	-	0.02
D	2.85	2.95	3.15	θ	0°	-	8°
E	2.60	2.80	3.00	θ1	3°	5°	7°
E1	1.55	1.65	1.75	θ2	6°	8°	10°

## 7.Important Notice

WAN SEMICONDUCTOR (NINGBO) CO.,LTD reserves the right to make corrections, enhancements, improvements and other changes to its semiconductor products and services and to discontinue any product or service. Buyers should obtain the latest relevant information before placing orders and should verify that such information is current and complete. All semiconductor products (also referred to herein as “components”) are sold subject to WANSEMI’s terms and conditions of sale supplied at the time of order acknowledgment.

WANSEMI warrants performance of its components to the specifications applicable at the time of sale, in accordance with the warranty in WANSEMI’s terms and conditions of sale of semiconductor products. Testing and other quality control techniques are used to the extent WANSEMI deems necessary to support this warranty. Except where mandated by applicable law, testing of all parameters of each component is not necessarily performed.

WANSEMI assumes no liability for applications assistance or the design of Buyers’ products. Buyers are responsible for their products and applications using WANSEMI components. To minimize the risks associated with Buyers’ products and applications, Buyers should provide adequate design and operating safeguards.

No WANSEMI components are authorized for use in FDA Class III (or similar life-critical medical equipment) unless authorized officers of the parties have executed a special agreement specifically governing such use.

Unless WANSEMI has specifically designated certain components which meet ISO/TS16949 requirements, mainly for automotive use, WANSEMI will not be responsible for any failure of such components to meet such requirements.